

Style D Residential Aluminum Fencing - 3 Rail Alternating Picket Top

Specifications

Material: 6063-T5 Aluminum • Pickets: 5/8" sq. x .050" Wall • Rails: 1" sq. x .055" Wall • PPG® TGIC Polyester Powder Coating

Screws: Hardened 410 Stainless Steel With Cr6 Plating & Colored Heads • All Sections Are Offered Pre-Assembled Or Un-Assembled

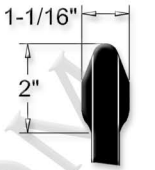

Picket Detail

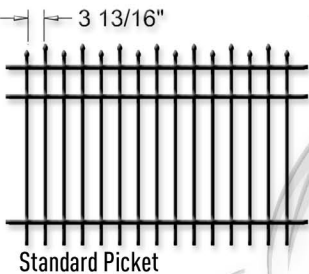
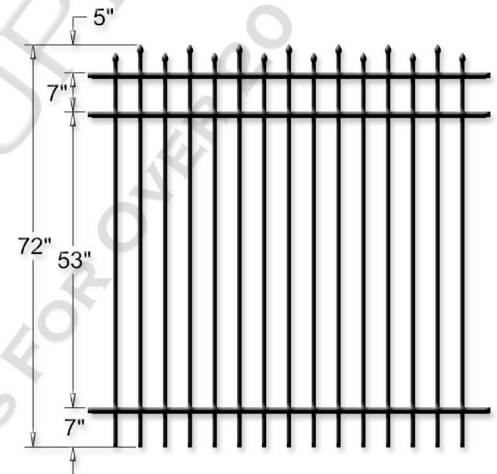
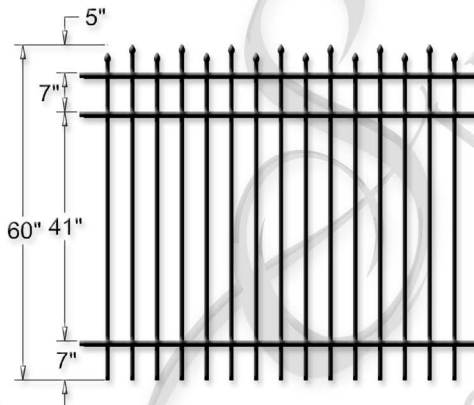
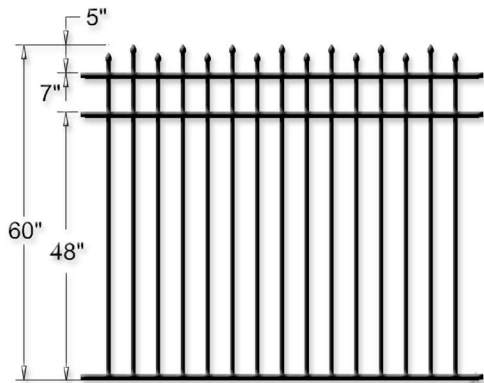
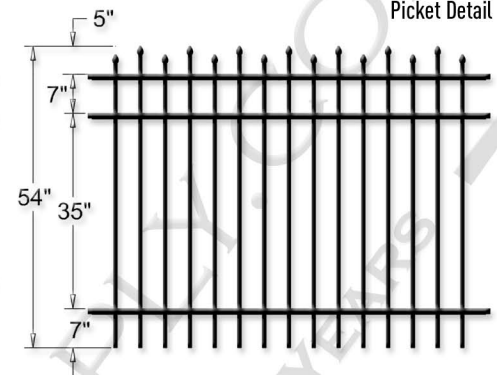
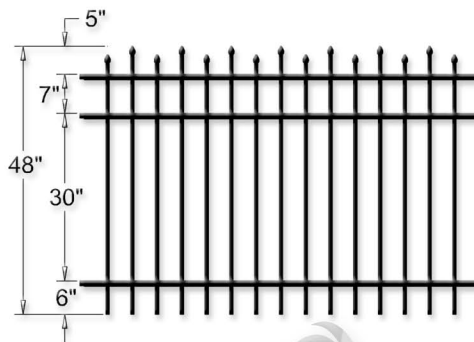
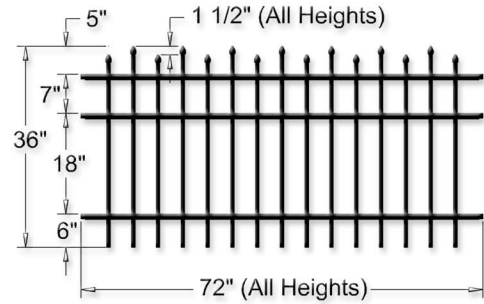

Standard Picket

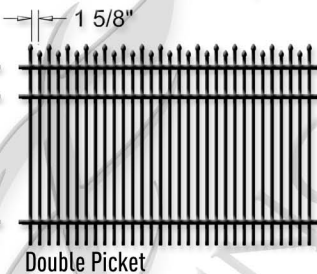

Double Picket

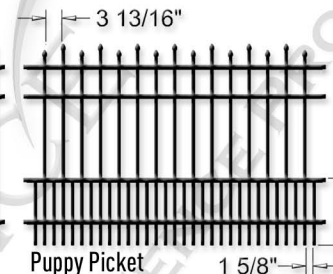

Puppy Picket

16" (36" & 48" Heights)
 20" (54", 60" & 72" Heights)

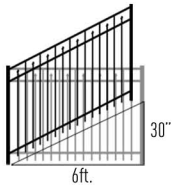

Sections can rack 30° over the 6ft. span to accommodate hilly terrain.

Style D Aluminum Fence Sections Are Available In Standard Picket, Double Picket & Puppy Picket Designs.

Style D Pool Code Approved Heights

Standard Picket Design: 60" Flush Bottom & 72" • Double Picket Design: 54", 60" & 72"

Please Note That 36" Height & Any Puppy Picket Design Fence Sections Do Not Meet Pool Code

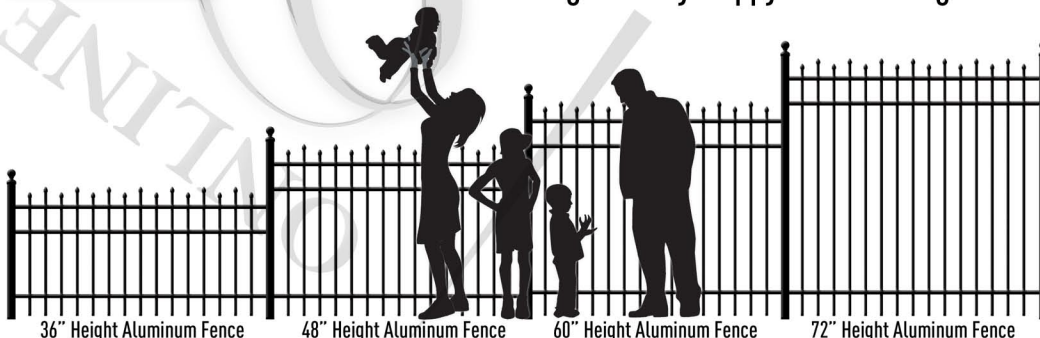

36" Height Aluminum Fence

48" Height Aluminum Fence

60" Height Aluminum Fence

72" Height Aluminum Fence